

Summary

1 CONNECTIONS	6
1.1 TEMPERATURE PROBES.....	6
1.2 PRESSURE PROBES.....	7
1.3 LOW VOLTAGE DIGITAL INPUTS.....	8
1.4 LIVE DIGITAL INPUTS.....	10
1.5 RELAY OUTPUTS.....	10
1.6 EXPANSION BOARD LOW VOLTAGE DIGITAL INPUTS.....	11
1.7 EXPANSION BOARD LIVE DIGITAL INPUTS.....	11
1.8 EXPANSION BOARD RELAY OUTPUTS.....	11
2 VOLTAGE/FREQUENCY INPUT	12
3 POWER SUPPLY.....	12
4 SERIAL CONNECTIONS	13
5 JUMPER.....	14
6 DESCRIPTION OF USER INTERFACE.....	15
6.1 UNIT STARTUP	15
6.2 UNIT SHUTDOWN	15
6.3 ENABLING A COMPRESSOR	15
6.4 DISABLING A COMPRESSOR	16
6.5 MEANING OF COMPRESSOR/CIRCUIT STATUS LED'S (A2).....	16
6.6 TEMPERATURE DISPLAY.....	17
6.6.1 Version C (Chiller).....	17
6.6.2 Versions R - Chiller with recovery and N - Heat pumps	17
6.6.3 Version FC (Chiller with free cooling).....	18
6.7 OPERATING MODE SELECTION	19
6.7.1 Version R.....	19
6.7.2 Version N.....	19
6.7.3 Version FC.....	19
6.8 ALARMS	20
6.8.1 Circuit and/or compressor alarms.....	20
6.8.2 General alarms.....	20
6.9 FLASHING LED'S.....	21
7 ALARM SIGNALS	22
8 REGULATION.....	24
8.1 CHILLED WATER REGULATION	24
8.1.1 Default set point settings.....	25
8.2 HOT WATER REGULATION	26
8.2.1 Default set point settings.....	27
8.3 FREE-COOLING REGULATION (ONLY FC VERSION).....	28
8.3.1 Default set point settings.....	28

9 ENABLE PRINTING.....	29
9.1 PARAMETER PRINTING.....	29
9.2 COMPRESSOR VARIABLES AND STATUS PRINTING.....	29
9.3 ALARM HISTORY PRINTING.....	30
9.4 LAMP TEST	31
9.5 PRINTER CHARACTERISTICS.....	32
10 UPGRADING EPROM.....	33
11 SELF-CALIBRATION.....	35
12 ACCESS TO THE PROGRAMMING MENU.....	36
13 PARAMETER LIST.....	37
14 ENCLOSURES.....	45

Board description

The system consists of a main board and keyboard. The main board communicates with the keyboard through a serial current-loop. A board with the microprocessor used to control the units is mounted on the main board. The management program is memorised in the EPROM, while the parameters, calibrations and history data are memorised in the EEPROM. The parameters are set through the keyboard.

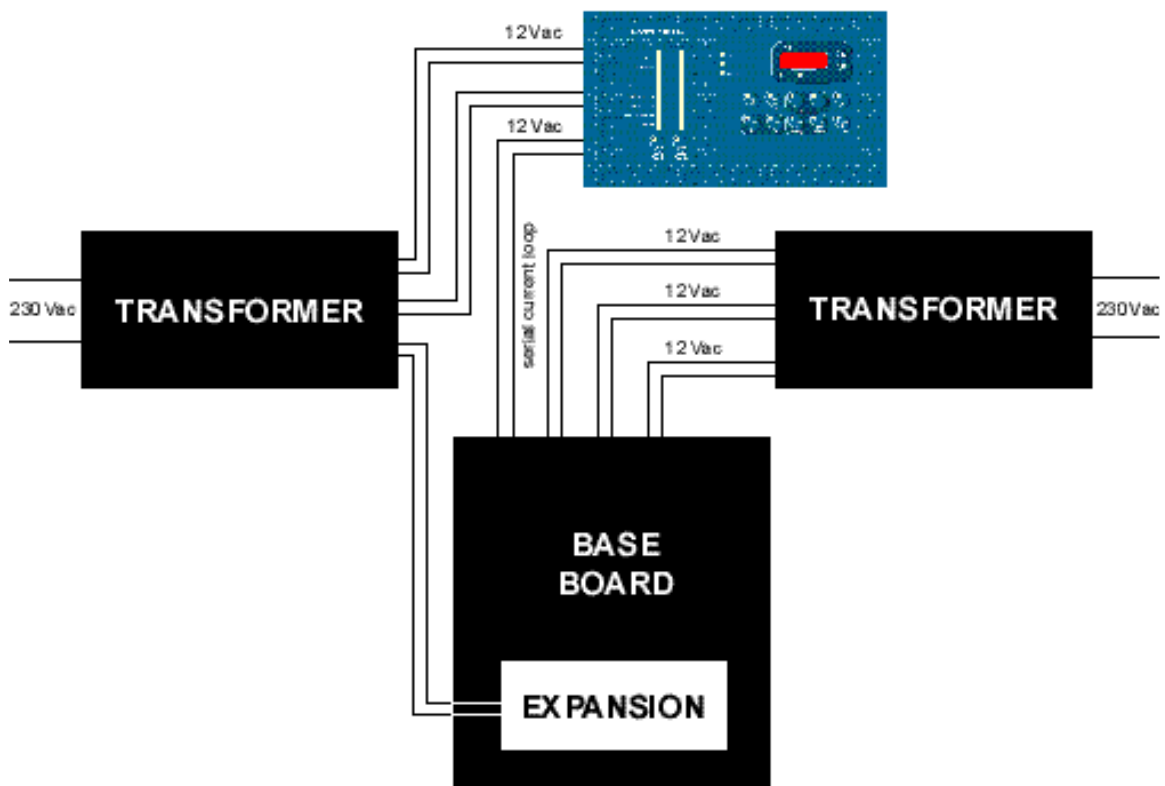

Figure 1-0 ELECTRONIC SYSTEM

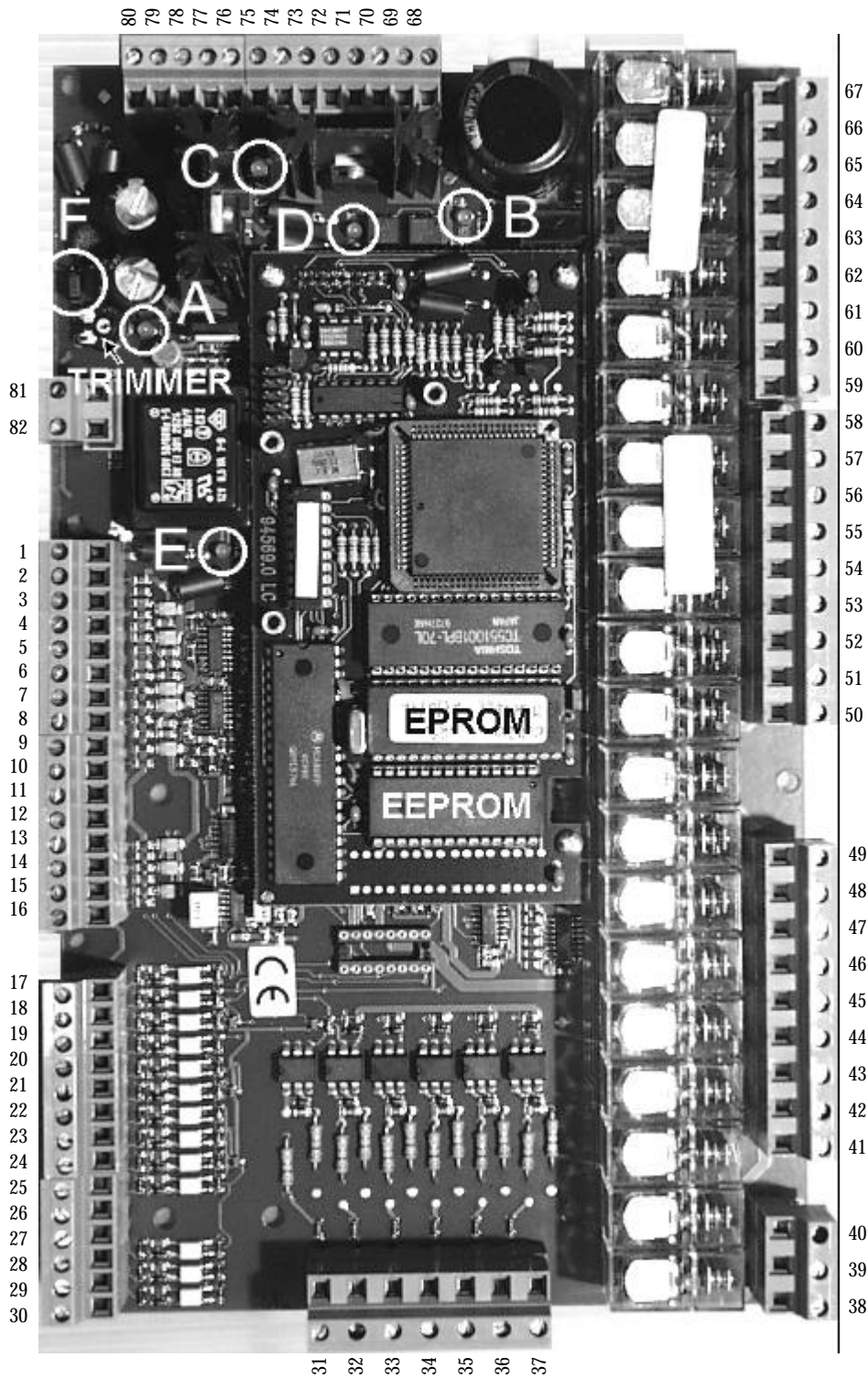

Figure 1-1 MAIN BOARD

Led	Meaning
A	12 Vac supply of terminals 79 - 80
B	12 Vac supply of terminals 68 - 68
C	12 Vac supply of terminals 70 - 71
D	COM3 serial Tx signal
E	COM3 serial Rx signal

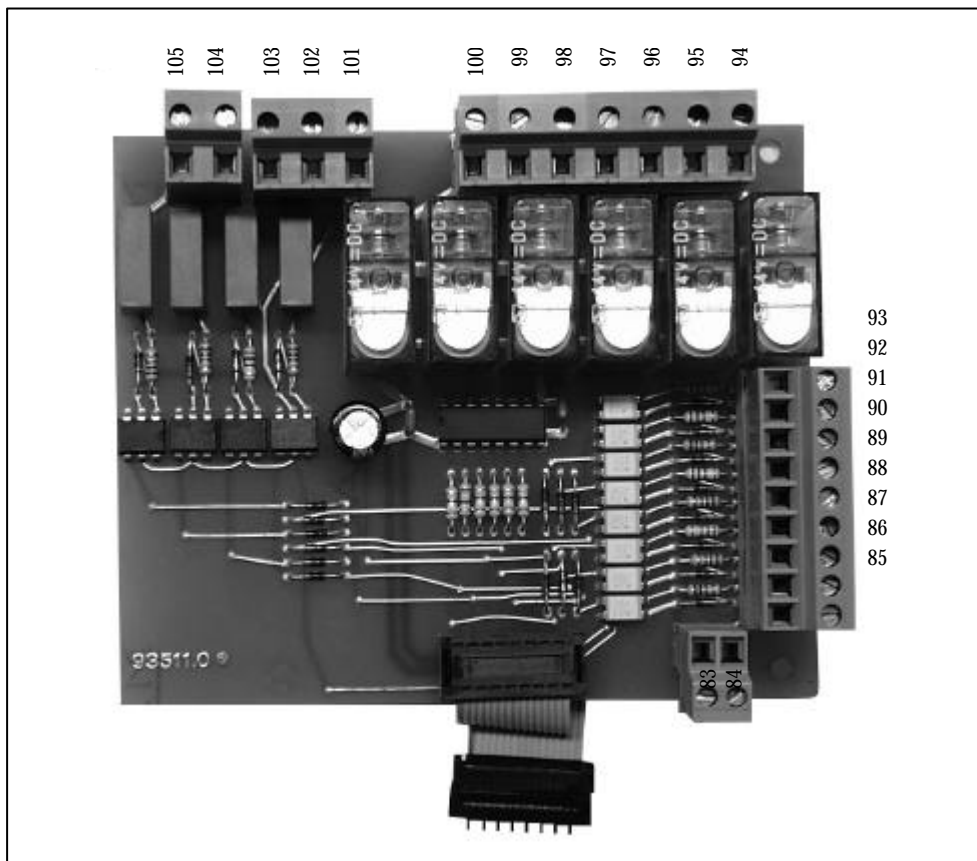

Figure 1 - 2

1 Connections

1.1 Temperature probes

The 6 PTC-type temperature probes for general use take on different meanings depending on the software configuration given to the machine configuration parameters.

Terminals	Meaning
6	PTC 1 probe input
8	PTC 2 probe input
10	PTC 3 probe input
12	PTC 4 probe input
14	PTC 5 probe input
16	PTC 6 probe input
5, 7, 9, 11, 13, 15	Common to all probes

Temperature [°C]	-55	-50	-40	-30	-20
Resistance [Ω]	485	510	562	617	677

Temperature [°C]	-10	0	10	20	25
Resistance [Ω]	740	807	877	951	990

Temperature [°C]	30	40	50	60	70
Resistance [Ω]	1029	1111	1196	1286	1378

Temperature [°C]	80	90	100	110	120
Resistance [Ω]	1475	1575	1679	1796	1896

Temperature probes verification procedure:

- disconnect the power supply to the unit;
- disconnect the probe from microprocessor's terminals;
- use a digital Ohmmeter to measure the resistance value of the probe;
- measure the temperature near the probe cap;
- compare the resistance value measured with the one shown in the table: the corresponding temperature must be approximately the same as the measured one.

1.2 Pressure probes

Two 4-20mA 0-30 bar pressure probes.

Terminals	Meaning
1	Circuit 1 condensing pressure probe power supply
2	Probe 1 4-20mA input
3	Circuit 2 condensing pressure probe power supply
4	Probe 2 4-20mA input

Pressure [Bar]	0.0	0.5	1.0	1.5	2.0	2.5	3.0	3.5
Current [mA]	4.00	4.27	4.54	4.80	5.07	5.34	5.61	5.87

Pressure [Bar]	4.0	4.5	5.0	5.5	6.0	6.5	7.0	7.5
Current [mA]	6.14	6.41	6.68	6.94	7.21	7.48	7.75	8.01

Pressure [Bar]	8.0	8.5	9.0	9.5	10.0	10.5	11.0	11.5
Current [mA]	8.28	8.55	8.82	9.08	9.35	9.62	9.89	10.15

Pressure [Bar]	12.0	12.5	13.0	13.5	14.0	14.5	15.0	15.5
Current [mA]	11.43	10.69	10.96	11.23	11.49	11.76	12.03	12.30

Pressure [Bar]	16.0	16.5	17.0	17.5	18.0	18.5	19.0	19.5
Current [mA]	12.56	12.83	13.10	13.37	13.63	13.90	14.17	14.44

Pressure [Bar]	20.0	20.5	21.0	21.5	22.0	22.5	23.0	23.5
Current [mA]	14.70	14.97	15.24	15.51	15.77	16.04	16.31	16.58

Pressure [Bar]	24.0	24.5	25.0	25.5	26.0	26.5	27.0	27.5
Current [mA]	16.84	17.11	17.38	17.65	17.92	18.18	18.45	18.72

Transducer verification procedure:

- disable the compressors and leave the unit with only “ON/OFF switch” ON;
- disconnect the cable from terminal 1 for probe 1, or 3 for probe 2;
- place a tester between terminal 1 or 3 and the disconnected cable and read the current value using a milliammeter;
- read the pressure value using a gauge placed near the pressure transducer;
- compare the readings with the values shown in the table.

1.3 Low voltage digital inputs

The inputs described below (BT) are low voltage inputs and must consist of voltage-free contacts.

Terminals	Meaning
17	Common
18	BT0 input: unit's remote ON/OFF control
19	BT1 input: Circuit 1 fan thermal overload protection
20	BT2 input: Circuit 2 fan thermal overload protection
21	BT3 input: Circuit 3 fan thermal overload protection
22	BT4 input: Circuit 4 fan thermal overload protection
23	BT5 input: circuit 1 HP pressure switch
24	BT6 input: circuit 2 HP pressure switch
25	BT7 input: circuit 1 LP pressure switch
26	BT8 input: circuit 2 LP pressure switch
27	BT9 input: circuit 1 OP pressure switch
28	BT10 input: circuit 2 OP pressure switch
29	BT11 input: Remote summer/winter mode control (only for heat pumps)
30	BT12 input:

Using the REMOTE ON/OFF control:

For proper use of the unit's remote on/off control, the following delay time must be set between the unit's on/off control and the water pump control:

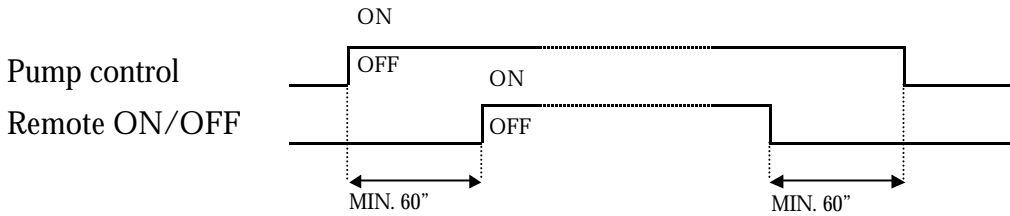

This is very important, because during the pump-down procedure (at compressor stop) the water pump must be on in order to carry it out correctly. Otherwise, if the flow switch intervenes, this could cause damage to the compressors. In this case Climaveneta will not cover warranty. Moreover, if the remote ON/OFF control is used (from an external contact or through protocol control) the following minimum time delays must be observed:

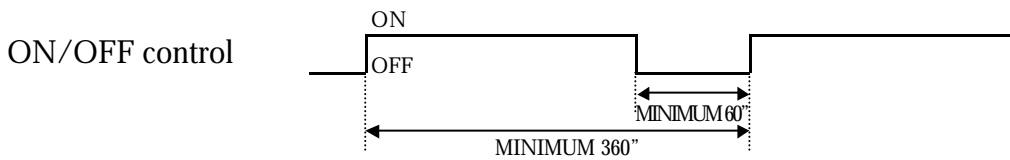

Electrical panel connection of the remote ON/OFF contact, if installed:

Remote ON/OFF contact

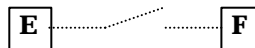

1.4 Live digital inputs

Terminals	Meaning
31	AT0 input: Compressor 1 maximum safety high pressure switch
32	AT1 input: Compressor 2 maximum safety high pressure switch
33	AT2 input: Compressor 1 thermal overload protection
34	AT3 input: Compressor 2 thermal overload protection
35	AT4 input: Primary circuit flow switch (*)
36	AT5 input: Secondary circuit flow switch (*)
37	Common (Neutral)

(*) A flow switch at the evaporator's outlet is mandatory to avoid the invalidation of the warranty

Connection to the electrical panel:

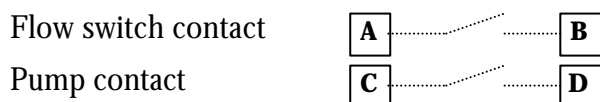

1.5 Relay outputs

RELAY terminals	NC	NO	COMMON
RL0	38	39	40
RL1	67		66
RL2	65		64
RL3		62	63
RL4		61	
RL5		59	60
RL6		58	
RL7		56	57
RL8		55	
RL9		53	54
RL10		52	
RL11		50	51
RL12		49	
RL13		48	
RL14		47	
RL15		46	45
RL16		44	
RL17		43	
RL18		42	
RL19		41	

1.6 Expansion board low voltage digital inputs

The inputs described below (BT) are low voltage inputs and must consist of voltage-free contacts.

Terminals	Meaning
85	Common
86	BT13 input: Circuit 3 HP pressure switch
87	BT14 input: Circuit 4 HP pressure switch
88	BT15 input: Circuit 3 LP pressure switch
89	BT16 input: Circuit 4 LP pressure switch
90	BT17 input: Circuit 3 OP pressure switch
91	BT18 input: Circuit 4 OP pressure switch
92	BT19 input
93	BT20 input

1.7 Expansion board live digital inputs

Terminals	Meaning
101	Common (Neutral)
102	AT5 input: Compressor 3 maximum safety high pressure switch
103	AT6 input: Compressor 4 maximum safety high pressure switch
104	AT7 input: Compressor 3 thermal overload protection
105	AT8 input: Compressor 4 thermal overload protection

1.8 Expansion board relay output

RELAY terminals	NC	NO	COMMON
RL20		94	97
RL21		95	
RL22		96	
RL23		98	
RL24		99	
RL25		100	

2 Voltage/frequency input

The main board has an input for monitoring the voltage and frequency value.

81 - **82** input for 0 -230 Vac voltage to be monitored.

Verification of the voltage value read by the board:

- read the voltage to terminals 81 and 82 using a tester:
- enter in the programming mode and visualise the value of parameter 93.

If the two values do not correspond, make the necessary calibration using the trimmer shown in Figure 1-1 MAIN BOARD.

N.B.: the value of parameter 93, indicated on display B2, is not updated dynamically. Update the displayed value using the B3 keys.

3 Power supply

Main board power supply:

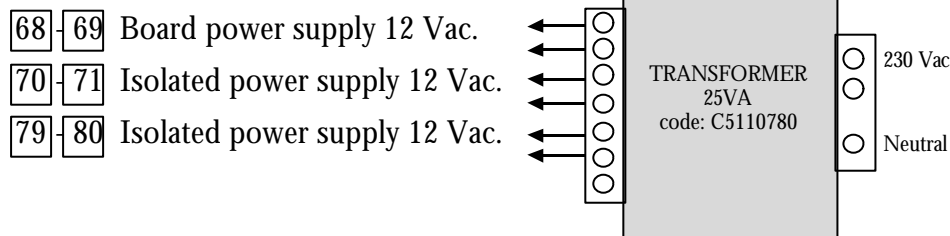

Keyboard and expansion unit power supply:

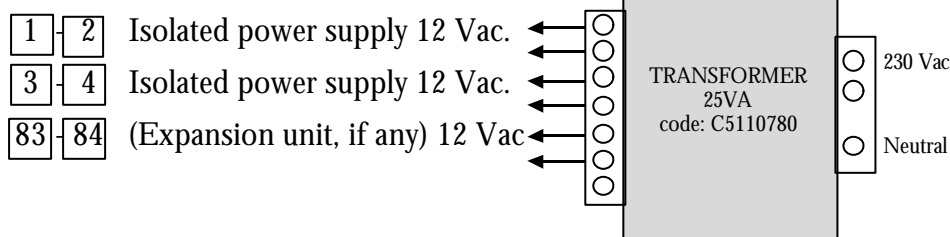

4 Serial connections

COM1: 0-20mA half duplex serial interface for connection with the display unit. This unit does not incorporate a 20mA power generator but uses the one installed in the display board.

<input type="checkbox"/>	72 input +	<input type="checkbox"/>	5 keyboard
<input type="checkbox"/>	73 output -	<input type="checkbox"/>	6 keyboard

COM2: 0-20mA half duplex serial interface for connection with the expansion board. This unit features an internal 20 mA generator. It must therefore be connected with modules that do not have an internal generator.



COM3: RS485 half duplex serial interface for connection to printer or supervision systems

<input type="checkbox"/> 76	RS485 +	99	} CLIMAVENETA RS 232/485 CONVERTER FOR PRINTER
<input type="checkbox"/> 77	RS485 -	100	
<input type="checkbox"/> 78	reference for RS485 COM3	98	

The cable used for the serial connections must be shielded type and must have at least 1 sq. mm wires for distances of less than 300 meters and 1.5 sq. mm wires for longer distances. The maximum distance of the cable that connects the CVM Master, the CVM Interface, the supervision software to the farthest unit must not exceed 1000 meters. As shown in the figure, the single shield sections must be connected to each other but not to the terminal boards:

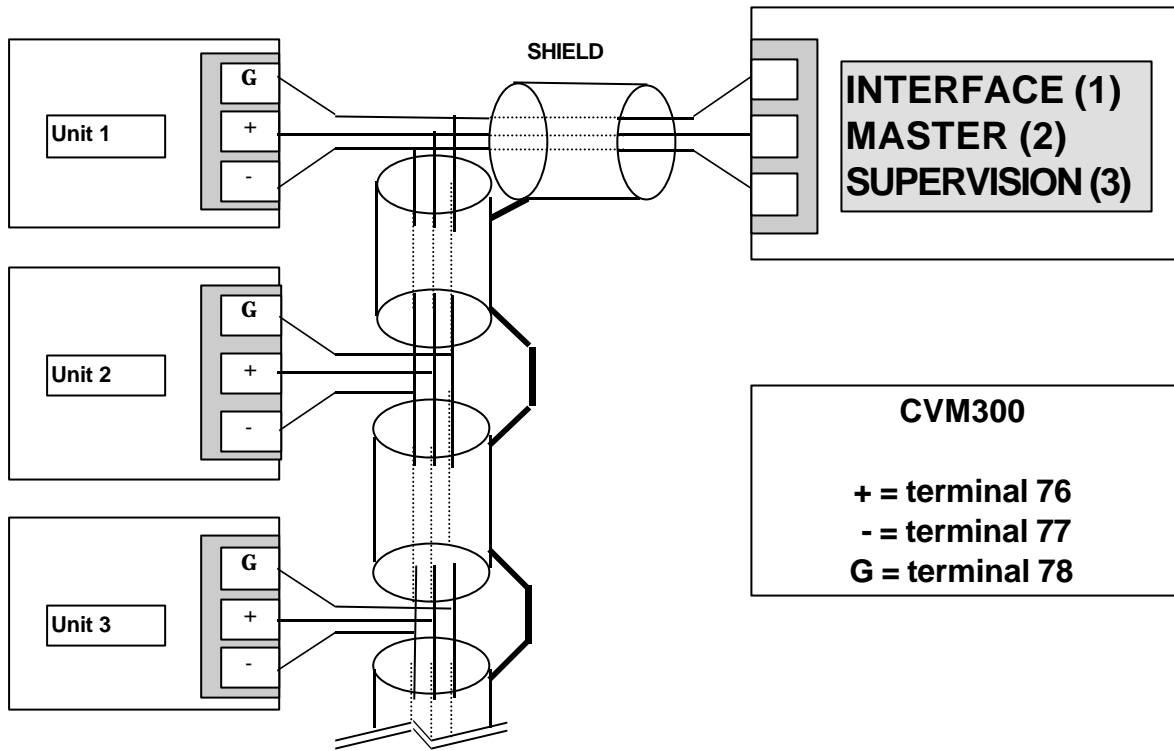

NB : maximum number of connected units = 8

NB: as indicated in the figure, a SINGLE serial cable must leave the CVM Master, the Interface, or the Supervision software to connect the first unit, then proceed to connect the other units successively.

COM4: RS485 half duplex serial interface (a serial expansion board is required).

- (1) Refer to manual for description and use.
- (2) Refer to manual for description and use.
- (3) Refer to manual for description and use.

5 Jumper

For proper operation of the board, make sure that the jumper in **Figure 11 MAIN BOARD**, point **F**, is **NOT** inserted.

Software

6 Description of user interface

The CVM_300 keyboards, up to 2 compressors, are shown in figures 1, 2, 3, 4 of the enclosures, respectively:

Fig. 1: CVM_300 C Chiller version

Fig. 2: CVM_300 R Chiller with heat recovery version

Fig. 3: CVM_300 N Heat pump version

Fig. 4: CVM_300 FC Free-Cooling version

If the **(B1) POWER** LED is on it means that the electronic control is supplied with power.

Before you switch on the unit, make sure that it has been supplied with power for at least 8 hours (in order to enable the heating of the oil and to avoid presence of refrigerant gas inside the compressor oil pan).

6.1 Unit start-up



Press the **T1** key

The LED of the key will light up.

6.2 Unit shutdown



Press the **T1** key

The LED of the key will go off.

6.3 Enabling a compressor



Press the **A1** key corresponding to the compressor to be enabled;

The LED of the key will light up.

The start-up of the enabled compressor may be delayed due to:

- the delays set in the parameters
- the water inlet temperature is under the cold water set point
- alarm.

6.4 Disabling a compressor



Press the **A1** key corresponding to the compressor to be disabled;
The LED of the key will go off.

Use this function only for emergency stops, since the pump-down procedure is not carried out and the compressor may suffer damage not covered by the warranty. For the correct compressor on/off procedure use the “ON/OFF switch” key.

6.5 Meaning of the compressor/circuit status LED's (A2)

LED REQUEST	LED OPERATION	
Off	Off	Compressor off
On	Off	Compressor requested but delayed
On	On	Compressor operating
Off	On	Shutdown with pump down procedure

VERSION	Third line LED
C	ABSENT
R	Operation in RECOVERY mode
N	Operation in DEFROST mode
FC	Operation in FREE-COOLING mode

ALARM LED	MEANING
low pressure	Low pressure
high pressure	High pressure
oil pressure	Oil differential pressure
compressor o.l.	Compressor thermal overload protection
fan o.l.	Fan thermal overload protection

6.6 Temperature display

6.6.1 Version C (Chiller)

Evaporator inlet temperature:



press the **T4** key – The LED of the key will light up



read the value on the **B2** display

Evaporator outlet temperature:



press the **T5** key – The LED of the key will light up



read the value on the **B2** display

6.6.2 R version - Chiller with recovery and N version – Heat pump

Evaporator inlet temperature



press the **T4** key (CHILLED WATER) - The LED of the key will light up



read the value on the **B2** display

Evaporator outlet temperature



press the **T5** key (CHILLED WATER) - The LED of the key will light up



read the value on the **B2** display

Condenser inlet temperature



press the **T4** key (HOT WATER)- The LED of the key will light up



read the value on the **B2** display

Condenser outlet temperature



press the **T5** key (HOT WATER)- The LED of the key will light up





read the value on the **B2** display



Warning: in the Heat Pump units (N) version the condenser inlet/outlet temperatures are displayed only when the unit is in Heat Pump mode.

6.6.3 FC version (Chiller with free cooling)



Free-cooling coil inlet temperature

-  press the **T17** key - The LED of the key will light up
-  read the value on the **B2** display

Free-cooling coil outlet temperature (evaporator inlet)

-  press the **T18** key - The LED of the key will light up
-  read the value on the **B2** display

Evaporator outlet temperature

-  press the **T19** key - The LED of the key will light up
-  read the value on the **B2** display

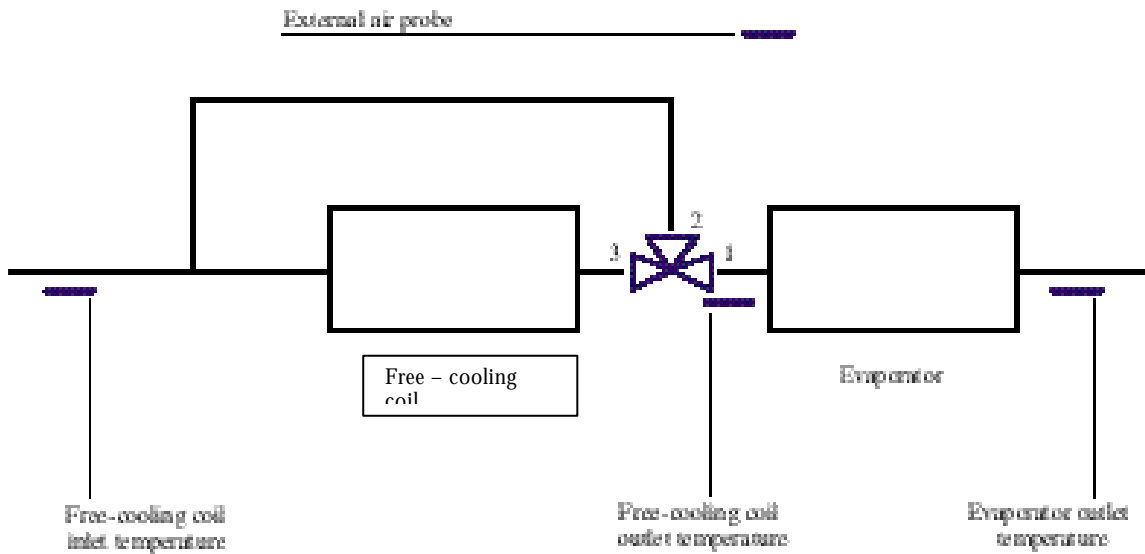

6.7 Operating mode selection

6.7.1 Version R

Selection of recovery operating mode

To select the recovery operating mode:



press the **T12** key - The LED of the key will light up

To deselect the recovery operating mode:



press the **T12** key - The LED of the key will go off

6.7.2 Version N

Selection of chiller operating mode

To select the chiller operating mode:



press the **T11** key - The LED of the key will light up

Selection of heat pump operating mode

To select the heat pump operating mode:



press the **T11** key - The LED of the key will go off

6.7.3 Version FC

Selection of free-cooling operating mode

To select the free-cooling operating mode:



press the **T15** key - The LED of the key will light up

To deselect the free-cooling operating mode:



press the **T15** key - The LED of the key will go off

6.8 ALARMS

NB: If microprocessor's data logger is enabled when a manual reset alarm appears (except for E003, E004, E020, E211, E203 and E213 which have automatic reset) the keyboard response will slow down for about a minute, which is the time required to store in the memory the status of the last 10 minutes of unit operation. During this phase it is important:

1. **DO NOT to access the programming menus.**
2. **DO NOT to disconnect the power supply to the unit.**

At the conclusion of this phase the keyboard will resume normal operating speed.

There are two types of alarm: the circuit/compressor and the general alarms.

6.8.1 Circuit and/or compressor alarms

Visualisation of circuit and compressor alarms



The circuit and/or compressor alarms are signalled by the lighting up of the LED corresponding to the compressor for which the alarm has activated (**A2**). Press the **T7** key – The alarm code will appear on the **B2** display.

Alarm reset:



press the **A1** key corresponding to the compressor in alarm status; if the event that caused the shutdown has been removed, the alarm will be reset (alarm LED flashing).

6.8.2 General alarms

Visualisation of general alarms



press the **T7** key – On the **B2** display the alarm code will appear. The corresponding **B1** LED will light up simultaneously in case of a flow switch or antifreeze alarm. In case of a voltage alarm, the **POWER** LED will flash.

Alarm reset:



















press the **T8** key; if the event that caused the alarm has been removed (alarm code on the display flashing) the alarm will be reset.

















6.9 FLASHING LED's

The flashing of the keyboard LED's may signal status or alarm conditions:

A1 key LED's	Visualisation on B2 display of the compressor alarms
A2 LED: DEFROST	<ul style="list-style-type: none"> Defrost time counting phase Stand-by time at the end of defrosting
A2 LED: RECOVERY	Condensation pressure too high in recovery operating mode: forced time in chiller operating mode
A2 LED: lp	The maximum number of low pressure, automatic reset alarms has been reached and therefore the alarm must be reset manually: manual reset is possible
A2 LED: hp	End of high pressure alarm: manual reset is possible
A2 LED: op	End of compressor oil pressure alarm: manual reset is possible
B1 LED: ICE	End of antifreeze alarm: manual reset is possible
B1 LED: Power	Mains voltage and/or frequency alarm
Led T1 ON/OFF	<ul style="list-style-type: none"> Forcing in OFF from serial connected remote control but not from remote ON/OFF contact; Unit shutdown in Pump Down mode
T7 key LED	Printing of parameters in progress
T13 key LED	Printing of variables in progress
T6 key LED	Printing of alarm list in progress

7 Alarm signals

CODE	ALARM	Type of reset	Cause
E000	Antifreeze	M	<ul style="list-style-type: none">  Not correct water flow rate to the evaporator  Water pump off  Incorrect setting of set point and Δt  Incorrect setting of antifreeze set point
E001	Mains voltage	A	<ul style="list-style-type: none">  Voltage values exceed limits set in parameters 3 and 4
E002	Mains frequency	A	<ul style="list-style-type: none">  Frequency values exceed limits set in parameters 5 and 6
E003	Chilled water circuit flow switch	A	<ul style="list-style-type: none">  Not correct water flow rate to the evaporator  Air bubbles in water circuit  Flow switch malfunction
E004	Hot water circuit flow switch	A	<ul style="list-style-type: none">  Not correct water flow rate to the condenser/recovery  Air bubbles in water circuit  Flow switch malfunction
E005	Low inlet temperature	Only on alarm list/A	<ul style="list-style-type: none">  This alarm is detected only for heat pump unit, after a chiller/heat pump switchover
E006	High inlet temperature	Only on alarm list/A	<ul style="list-style-type: none">  This alarm is detected only for heat pump unit, after a chiller/heat pump switchover
E020	Incorrect configuration	A	<ul style="list-style-type: none">  Error in the programming of the configuration parameters
E035	CVM Master disconnected	A	<ul style="list-style-type: none">  No communication with the CVM Master







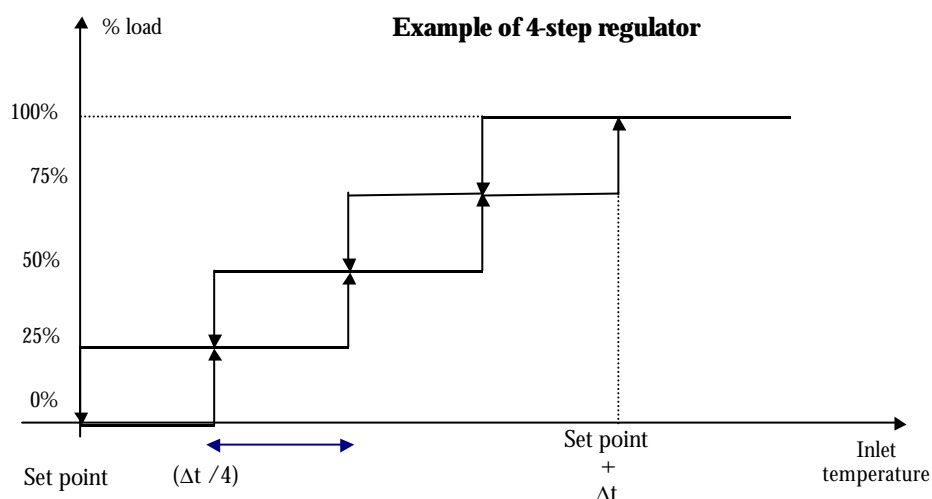

E036	Keyboard disconnected	Only on alarm list/A	 No communication with the keyboard (the Coll message appears on the C2 display and the alarm code is recorded in the alarm list)
E101	Oil differential pressure	M	 Low compressor oil pressure
E103	Thermal overload protection	M	 Compressor motor overheating
E116	Maximum safety high pressure switch	M	 High condensing pressure
E201	High pressure	M	 High condensing pressure
E202	Fan thermal overload protection	M	 Fan motor overheating
E203	Pump down pressure	A	 The circuit has not reached the pump-down pressure set
E207	High pressure transducer error	M	 Pressure transducer malfunction
E208	Defrost temperature probe error	A	 Failure of temperature probe placed on the evaporating coil
E211	Maximum defrost time	A	 The unit has not reached the defrost end temperature set
E213	Low pressure	A/M	 Not correct flow rate to the evaporator  Dirty evaporator  Insufficient refrigerant gas charge
E214	Modem disconnected	A	 Modem off  No power to converter  Defective connection
E4XX	Temperature probe error	A	 Malfunction in one of the temperature probes

M = manual reset alarm
A = automatic reset alarm
A/M = automatic reset alarm for a programmable number of events/hour

8 Regulation

8.1 Chilled water regulation



-  Press the **T2** key – The LED of the key will light up
-  the value of the set point will appear on the **B2** display
-  modify the set point using the **B3** keys:
 - arrow up to increase
 - arrow down to decrease
-  press the **T2** key to confirm - The LED of the key will go off
-  press the **T3** key to confirm - The LED of the key will light up
-  the value of the Δt setting will appear on the **B2** display
-  modify the value of the Δt using the **B3** keys:
 - arrow up to increase
 - arrow down to decrease
-  press the **T3** key to confirm - The LED of the key will go off.

8.1.1 Default set point settings

The following table shows, based on the number of steps, the commonly used set point and Δt values.

The theoretical minimum and maximum values indicated in the table for the outlet temperature refer to nominal flow rate operation, and therefore with a 5° C evaporator thermal head.







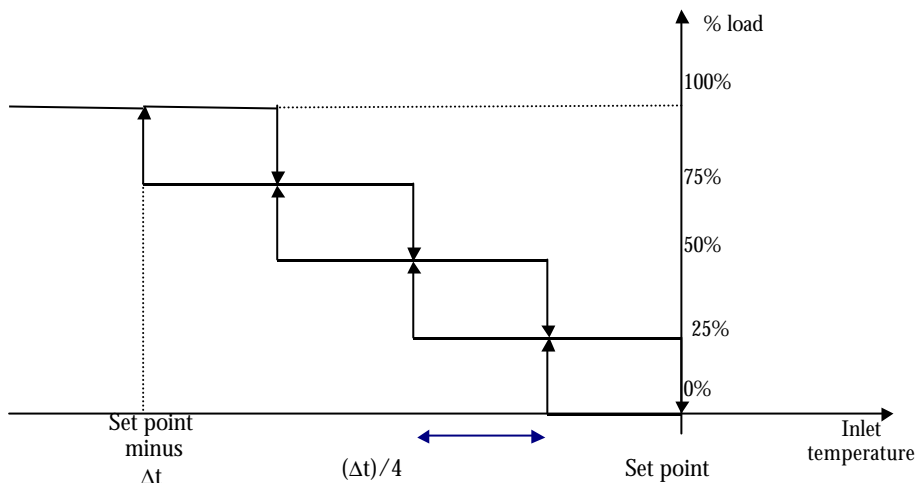

No. of steps	Set point [°C]	Δt [°C]	Theoret. min out temp.	Theoret. max out temp
1	11	1	6	12
2	9.5	2.5	5.7	10.8
3	8	4	5.6	9.4
>=4	7	5	<=5.7	<=8.3

Warning: the regulation is made based on the temperature reading at the evaporator's inlet.

8.2 Hot water regulation

Example of 4-step regulator



-  Press the **T9** key – The LED of the key will light up
-  the value of the set point will appear on the **B2** display
-  modify the set point using the **B3** keys:
 - arrow up to increase
 - arrow down to decrease
-  press the **T9** key to confirm - The LED of the key will go off
-  press the **T10** key – The LED of the key will light up
-  the value of the Δt setting will appear on the **B2** display
-  modify the value of the Δt using the **B3** keys:
 - arrow up to increase
 - arrow down to decrease
-  press the **T10** key to confirm - The LED of the key will light up

8.2.1 Default set point settings

The following table shows, based on the number of steps, the commonly used set point and Δt values.

The theoretical minimum and maximum values indicated in the table for the outlet temperature refer to nominal flow rate operation, and therefore with a 5° C evaporator thermal head.

No. of steps	Set point [°C]	Δt [°C]	Theoret. min out temp.	Theoret. max out temp.
1	41	1	40	46
2	42.5	2.5	41.2	46.3
3	44	4	42.6	46.4
≥ 4	45	5	≤ 43.7	≤ 46.3

Warning: the regulation is made based on the temperature reading at the evaporator's inlet.

8.3 Free-cooling regulation (only FC version)

The regulation is made using the **T15** key.

Key **T24** allows you to visualise the set point variation compared to the value set with the **T2** key (the set point variation is enabled through parameter 97).

Key **T25** allows you to visualise the actual thermal head between the unit's inlet and outlet temperatures.

These visualisations appear on the **B2** display.

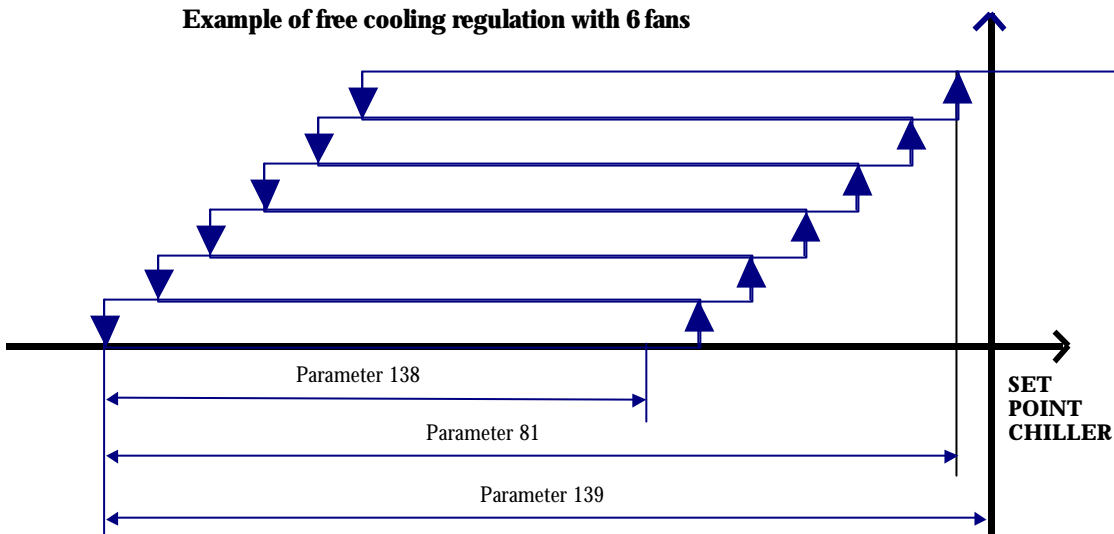

8.3.1 Default set point settings

NB: refer to the figure above.

N.	MACHINE PARAMETERS	RANGE	DEFAULT
81	PROPORTIONAL BAND FOR FAN REGULATION IN FREE COOLING OPERATING MODE	0 ↔ 500	2 °C
85	PRIMARY CIRCUIT INTEGRAL TIME	0 ↔ 600	0 sec
87	SECONDARY CIRCUIT INTEGRAL TIME	0 ↔ 600	0 sec
98	MINIMUM DIFFERENCE BETWEEN INLET WATER TEMPERATURE AND EXTERNAL AIR TEMPERATURE FOR THE STARTING OF FREE COOLING OPERATION	0 ↔ 50	1 °C
99	MAXIMUM DIFFERENCE BETWEEN EXTERNAL AIR TEMPERATURE AND INLET WATER TEMPERATURE FOR THE END OF FREE COOLING OPERATION	0 ↔ 50	1 °C
138	FAN ACTIVATION HYSTERESIS IN FREE-COOLING MODE	-10 ↔ 10	1 °C
139	FAN ACTIVATION OFFSET IN FREE-COOLING MODE	-10 ↔ 10	2 °C
140	FAN SHUTDOWN DELAY IN FREE-COOLING MODE	0 ↔ 500	20 sec
141	FAN STARTUP DELAY IN FREE-COOLING MODE	0 ↔ 500	20 sec

9 Enable printing

The data are accessible through the RS485 serial port on the main board, to which a serial printer can be connected for delivering the contents of the files (DPU printer – 114, paragraph 12.5). During the printout, the enable printing key flashes. If the print command is repeated while printing is in progress, the operation will be interrupted.

NB: to enable printing, the value of parameter 1 must be set to 0. For printing you can use the printer and converter supplied by Climaveneta, or the Service software.

9.1 Parameter printing

NASCOSTO 1* + T 13 for Version-C;

NASCOSTO 1* + T 7 for Version -R and Version-N and Version-FC;

Each line of print has the following structure:

1. parameter number;
2. parameter value;
3. unit of measurement.

For the printing of pressure values, the unit of measurement and the position of the decimal point must be compatible with parameter 2.

9.2 Compressor variables and status printing

NASCOSTO 1* + T 14 for Version-C;

NASCOSTO 1* + T 13 for Version-R and Version -N and Version -FC;

The lines with the probe values have the following structure:

1. probe number;
2. measurement value;
3. unit of measurement.

If the probe has not been selected, “- -” appears instead of the value, if the probe is faulty, “Error” appears.

(*) For information on these keys, contact the Climaveneta Customer Service Dept.

The lines with the compressor status have the following structure:

1. Compressor number
2. Status: Alarm, Deselected, On, Off.
3. Compressor working hours

9.3 Alarm history printing

NASCOSTO 1 + T 8 for Version -C;

NASCOSTO 1 + T 6 for Version -R and Version -N and Version -FC;

The record printout has 45 columns and is structured as follows:

	DESCRIPTION	LIMITS
1	Progressive print number	001-200
2	Number of hours between the event and the current hour	
3	Alarm code	000-299
4	Number of events in the indicated hour	1-32
5	Compressor or circuit number	1-8
6	29-character alphanumeric string for alarm description and associated compressor and/or circuit number to which the alarm refers	

Example:

```

?                ** ALARM HISTORY **

PROG HR  FREQ/  CIRC  COD.  DESCR.
.No.    HR     .  ALM.  ALM.
24  0   02      000  ANTIFREEZE
23  0   01      201  MAXIMUM PRESSURE
22  0   01      101  MAXIMUM PRESSURE
21  2   02      216  MAXIMUM PRESSURE
20  2   01      101  MAXIMUM PRESSURE
19  2   02      116  MAXIMUM PRESSURE
18  2   03      213  MINIMUM PRESSURE
17  2   03      123  MINIMUM PRESSURE
16  3   03      101  OIL DIFFERENTIAL
15  3   01      101  OIL DIFFERENTIAL
14  3   01      207  MAXIMUM PRESSURE PROBE
13  3   01      107  MAXIMUM PRESSURE PROBE
12  3   01      404  TEMPERATURE PROBE ERROR
11  3   01      203  TEMPERATURE PROBE ERROR
10  3   01      406  TEMPERATURE PROBE ERROR
9   3   01      405  TEMPERATURE PROBE ERROR
8   3   01      402  TEMPERATURE PROBE ERROR
7   3   01      401  TEMPERATURE PROBE ERROR
6   3   01      202  FAN THERMAL PROTECTION
5   3   01      102  FAN THERMAL PROTECTION
4   3   01      203  THERMAL PROTECTION
3   3   01      103  THERMAL PROTECTION
2   3   01      001  MAINS VOLTAGE
1   3   01      003  COLD FLOW SWITCH INLET

```

9.4 Lamp test

NASCOSTO 1* + T 7 for Version -C;



NASCOSTO 1* + T 8 for Version -R and Version -N and Version -FC;

Procedure for lighting up all the front panel LED's and displays in order to verify the proper keyboard and display operation.

(*)For information on these keys, contact the Climaveneta Customer Service Dept.

9.5 Printer characteristics

To check the setting of the DPU-414 printer:

-  press the printer's ON LINE (for at least 2 SECONDS) and POWER ON keys simultaneously. The configuration of the software dip-switches will be printed.
-  press the FEED key to exit from the programming.

The setting is correct if the print corresponds to the following list:

Dip SW-1

- 1 (OFF): Input=Serial
- 2 (ON): Printing Speed=High
- 3 (OFF): Auto Loading=OFF
- 4 (OFF): Auto LF=OFF
- 5 (ON): Setting Command=Enable
- 6 (OFF): Printing
- 7 (ON): Density
- 8 (ON): =100 %

Dip SW-2

- 1 (OFF): Printing Columns=80
- 2 (ON): User Font Back-up=ON
- 3 (ON): Character Select=Normal
- 4 (ON): Zero=Normal
- 5 (ON): International
- 6 (ON): Character
- 7 (OFF): Set
- 8 (OFF): =England

Dip SW-3

- 1 (ON): Data Length=8bits
- 2 (ON): Parity Setting=NO
- 3 (OFF): Parity Condition=Even
- 4 (OFF): Busy Control=XON/XOFF
- 5 (OFF): Baud
- 6 (ON): Rate
- 7 (ON): Select
- 8 (ON): =9600 bps

If the configuration of the dip-switches differs from the one shown above, consult the printer operating manual or contact CLIMAVENETA.

10 Upgrading Eprom

The software version is identified by the following code:

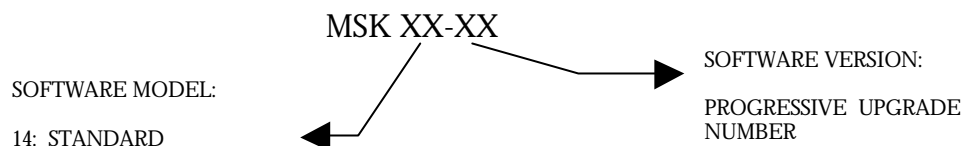

1. disable the compressors (see chap. 9.4);
2. the B2 display must be off;
3. print the parameters (see chap. 12);
4. disconnect the power supply to the unit;
5. remove the EPROM (Figure 1-1 MAIN BOARD) from its base;
6. install the new EPROM; be careful not to touch the pins with your fingers;
7. install the self-calibration kit in the appropriate board terminals;
8. reconnect the power supply;
9. wait for the end of the COLL which will flash on the display (only in case of upgrade from an MSK14_21 version or older to an improved one);
10. to access the programming menu, press the NASCOSTO 2* + B3 keys, "arrow up". A dot should start flashing on the B2 display;
11. scroll through the parameter list using the B3 keys until the "PASS" message appears;
12. press the T6 key and enter the password using the B3 keys;
13. press the T6 key to return to the parameter list;
14. scroll through the parameter list using the B3 keys until parameter 120 appears;
15. press the NASCOSTO 1*+B3 key, "arrow up". The LED of the T7 key will light up. Wait until the LED of the T7 key goes off;
16. scroll through the parameter list using the B3 keys until parameter 121 appears;

(*) For information on these keys, contact the Climaveneta Customer Service Dept.

17. repeat point 15 until the value that appears on the B2 display, regarding parameters 120, 121, 152, 153, corresponds to the one shown in the table:

PARAMETER	VALUE
120	50.0 + parameter offset value
121	-20.0 + parameter offset value
152	25.0 + parameter offset value
153	05.0 + parameter offset value

18. exit from the programming menu, press the NASCOSTO 2* + B3 keys, “arrow up”;
19. disconnect the power supply to the unit;
20. remove the self-calibration kit;
21. reconnect the power supply to the unit;
22. enter the programming menu (see point 10);
23. re-program the unit (check the value of the parameters by printing them, and set the value of any new parameters). Scroll through the parameter list using the B3 keys. Press T6 to visualise the value of the indicated parameter, and press the B3 keys to modify its value. To return to the parameter list press the T6 key again;
24. exit from the programming menu (see point 18);
25. disconnect the power supply to the unit;
26. reconnect the power supply to the unit;
27. enable the compressors (see chap.9.3).

(*)For information on these keys, contact the Climaveneta Customer Service Dept.

11 Self-calibration

1. Disable the compressors (see chap.9.4);
2. the B2 display must be off;
3. disconnect the power supply to the unit;
4. install the self-calibration kit ** in the appropriate board terminals;
5. reconnect the power supply to the unit;
6. to access the programming menu press the NASCOSTO 2* + B3 keys, “arrow up”. A dot should start flashing on the B2 display;
7. scroll through the parameter list using the B3 keys until parameter 120 appears;
8. press the NASCOSTO 1*+B3 key, “arrow up”. The LED of the T7 key will light up. Wait until the T7 key LED goes off;
9. scroll through the parameter list using the B3 keys until parameter 121 appears;
10. repeat step 8 until the values of parameters 120, 121, 152, 153 are, respectively:

PARAMETER	VALUE
120	50.0 + parameter offset value
121	-20.0 + parameter offset value
152	25.0 + parameter offset value
153	05.0 + parameter offset value

Table 1 Self-calibration values

8. to exit from the programming menu press the NASCOSTO 2* + B3 keys, “arrow up”;
9. disconnect the power supply to the unit;
10. remove the self-calibration kit;
11. reconnect the power supply to the unit;
12. enable the compressors.

(*) For information on these keys, contact the Climaveneta Customer Service Dept.

(**) Refer to manual for description and use.

Setup

12 Access to the programming menu

To access the USER menu:

1. disable the compressors (see chap.9.4);
2. the B2 display must be off;
3. to access the programming menu, press the NASCOSTO 2* + B3 keys, “arrow up”. A dot should start flashing on the B2 display if the procedure was done properly;
4. scroll through the parameter list using the B3 keys;
5. to visualise the value of the indicated parameter press T6, and to modify its value press the B3 keys. To return to the parameter list press the T6 key again;
6. to exit the programming menu press the NASCOSTO 2* + B3 keys, “arrow up”;
7. enable the compressors (see chap.9.3).

To access the FACTORY menu:

1. repeat points 1 to 3 of the user parameter access procedure;
2. scroll through the parameter list using the B3 keys until the “PASS” message appears;
3. press the T6 key and enter the password using the B3 keys;
4. press the T6 key to return to the parameter list;
5. repeat points 4 and 5 of the user parameter access procedure;
6. to exit from the programming press the NASCOSTO 2* + B3 keys, “arrow up”;
7. enable the compressors (see chap.9.3).

(*) For information on these keys, contact the Climaveneta Customer Service Dept.

13 Parameter list

[] = USER PARAMETERS

M = MACHINE PARAMETERS

CI = CIRCUIT PARAMETERS

CO = COMPRESSOR PARAMETERS

N.	TYPE	MACHINE PARAMETERS	RANGE	DEFAULT
0	CI	LOW PRESSURE ALARM DELAY TIME	0 ↔ 500	120 sec
1	M	ALLOWS YOU TO SELECT THE DEVICE TO BE CONNECTED TO THE COM3 SERIAL PORT	0 :PRINTER 1:CVM MASTER, 2: SUPERVISION 3: ----- 4: INTERFACE	0
2	CI	PRESSURE UNIT OF MEASUREMENT:	0: BAR 1: MEGAPASCAL	1 flag
3	M	VOLTAGE CONTROL SETTING MAXIMUM VALUE	0 ↔ 500	242 Volt
4	M	VOLTAGE CONTROL SETTING MINIMUM VALUE	0 ↔ 500	198 Volt
5	M	MAINS FREQUENCY	38 ↔ 62	50 Hz
6	M	MAINS FREQUENCY DELTA	1 ↔ 10	2 Hz
7	M	VOLTAGE/ FREQUENCY ALARM DELAY	0 ↔ 10	5 sec
8	M	ANTIFREEZE ALARM DIFFERENTIAL	0 ↔ 20	4 °C
9	CO	MINIMUM TIME BETWEEN COMPRESSOR SHUTDOWN AND STARTUP	0 ↔ 500	60 sec
10	M	MINIMUM STARTUP DELAY TIME BETWEEN COMPRESSORS (ANTIPEAK)	0 ↔ 500	10 sec
11	M	DELAY TIME BETWEEN STEPS SWITCHING ON	0 ↔ 500	0 sec
12	M	DELAY TIME BETWEEN STEPS SWITCHING OFF	0 ↔ 500	0 sec
13	M	COLD WATER FLOW SWITCH ALARM RESET DELAY	0 ↔ 500	10 sec
14	M	HOT WATER FLOW SWITCH ALARM RESET DELAY	0 ↔ 500	10 sec

15	M	START FREE-COOLING OPERATION DELAY TIME	0 ↔ 200	10 sec
16	M	STOP FREE-COOLING OPERATION DELAY TIME	0 ↔ 200	10 sec
17	M	GAIN FACTOR FOR MAINS VOLTAGE READING	1 ↔ 200	100
18	CO	COMPRESSOR OIL DIFFERENTIAL PRESSURE ALARM DELAY	0 ↔ 500	Tab. 13-3
19	M	UNIT IDENTIFICATION CODE FOR CVM MASTER, INTERFACE, SOFTWARE, SUPERVISION	11 ↔ 18	11-18

20	CI	CONFIGURATION OF CIRCUIT N° 1	1-12	Tab. 13-1
21	CI	CONFIGURATION OF CIRCUIT N° 2	0-12	Tab. 13-1
22	CI	CONFIGURATION OF CIRCUIT N° 3	0-12	Tab. 13-1
23	CI	CONFIGURATION OF CIRCUIT N° 4	0-12	Tab. 13-1

PARAMETER VALUE	No. OF CAPACITY STEPS PER COMPRESSOR:	No. OF COMPRESSORS PER CIRCUIT:
0	0	0
1	0	1
2	0	2
3	0	3
4	1	1
5	1	2
6	1	3
7	2	1
8	2	2
9	2	3
10	3	1
11	3	2
12	3	3

Table 13-1 REFRIGERANT CIRCUIT CONFIGURATION

R22 (Bar) R407C		R134A (Bar)		
SET	DIFF.	SET	DIFF.	
2.8	1.4	1.0	0.7	WATER-COOLED UNITS
1.6	0.9	0.6	0.7	AIR-COOLED UNITS
1.6	0.9	0.6	0.7	FOR LOW OUTLET WATER TEMPERATURE (> -5°C) AND FOR EXTERNAL AIR LOW TEMPERATURE DEVICE
1.0	0.7			FOR LOW WATER TEMPERATURE (<= A -5°C)

Table 13-2 LOW PRESSURE SWITCH SET

TYPE OF COMPRESSOR	SET	(PAR. DELAY 18)
COPELAND UP TO 60 Hp	0.7	120
COPELAND OVER 60 Hp	1.2	45
REFCOMP SERIES "F" AND "M"	1.8	60

Table 13-3 COMPRESSOR OIL DIFFERENTIAL PRESSURE SWITCH SET

31	C	HIGH PRESSURE ALARM SET	10.0 ↔ 28.0	Tab. 13-4
32	C	HIGH PRESSURE ALARM DIFFERENTIAL	0.0 ↔ 10.0	Tab. 13-4

	SAFETY VALVE SET	MAX SAFETY HIGH PRESSURE SWITCH SET		HIGH PRESSURE ALARM SET	
		SET	RESET	(PAR. 31) SET	(PAR. 32) DIFFERENTIAL
23.3		21.8	16.3	20.8	5.3
24.5		23	17.5	22 (22.8*)	5.5 (6.3*)
27		25.5	19.5	24.5	6
27.6		26.1	20.1	25.1	6
28		26.5	20.5	25.5	6

(*) ON HEAT PUMP UNIT WITH ISPEL SHELL AND TUBE HEAT EXCHANGER
Table 13-4 HIGH PRESSURE ALARM SET

35	M	MINIMUM TIME BETWEEN TWO SUCCESSIVE COMPRESSOR STARTUPS	0 ↔ 600	360 sec
36	C	PRESSURE SET FOR FORCED VENTILATION DURING DEFROSTING	10.0 ↔ 28.0	23.5 Bar
38	C	MAXIMUM NUMBER OF LOW PRESSURE ALARMS PER HOUR	0 ↔ 30	3 Num
39	M	COMPRESSOR STARTUP/SHUTDOWN MODE BY THE THERMOREGULATOR	0=ENABLE COMPRESSOR CAPACITY STEP OF ALL THE COMPRESSORS BEFORE SHUTDOWN 1= ENABLE COMPRESSOR CAPACITY STEP AND SHUT DOWN EACH SINGLE COMPRESSOR	1 Num

40	C	PUMP-DOWN CONFIGURATION CIRCUIT N° 1	0 ↔ 2	Tab. 13-5
41	C	PUMP-DOWN CONFIGURATION CIRCUIT N° 2	0 ↔ 2	Tab. 13-5
42	C	PUMP-DOWN CONFIGURATION CIRCUIT N° 3	0 ↔ 2	Tab. 13-5
43	C	PUMP-DOWN CONFIGURATION CIRCUIT N° 4	0 ↔ 2	Tab. 13-5

PARAMETER VALUE	DESCRIPTION
0	SHUTDOWN WITHOUT PUMP DOWN
1	SHUTDOWN WITH PUMP DOWN
2	SHUTDOWN WITH PUMP DOWN ONLY IN CHILLER MODE

Table 13-5 CIRCUITS PUMP DOWN CONFIGURATION

51	C	STAND-BY TIME TO BEGIN DEFROST CYCLE	0 ↔ 3600	1800 sec
52	C	AIR TEMPERATURE SET TO BEGIN DEFROST CYCLE AFTER TIME COUNTING AS PER PARAMETER 51	-10 ↔ 20	3.0 °C
53	C	TEMPERATURE SET FOR END OF DEFROSTING PROCEDURE	0 ↔ 30	10.0 °C
54	C	MAXIMUM TIME FOR END OF DEFROST CYCLE	0 ↔ 600	300 sec

55	C	PRESSURE SET FOR FORCING IN CHILLER MODE UNITS WITH RECOVERY	10.0 ↔ 28.0	23.5 Bar
56	C	PRESSURE DIFFERENTIAL FOR END OF FORCING IN CHILLER MODE UNITS WITH RECOVERY	0 ↔ 10	5.0 Bar
57	C	MINIMUM TIME OF CHILLER MODE OPERATION AFTER FORCING, IN UNITS WITH RECOVERY	0 ↔ 500	120 sec
58	M	ANTIFREEZE SET LOWER LIMIT	-50 ↔ 20	3 °C
59	M	TYPE OF DEFROSTING IN AIR/WATER HEAT PUMPS	0=NORMAL 1=SIMULT.	0
60	C	COMPRESSOR STARTUP STAND-BY TIME AFTER DEFROSTING PROCEDURE	0 ↔ 500	120 sec
61	M	ANTIFREEZE SET UPPER LIMIT	-20 ↔ 20	10.0 °C
62	C	MAXIMUM TIME OF OPERATION IN PUMP-DOWN MODE	0 ↔ 100	30 sec
63	M	ANTIFREEZE OFFSET ON HOT WATER CIRCUIT COMPARED TO COLD WATER ANTIFREEZE SET	-50 ↔ 50	0.0 °C
64	M	UNIT CONFIGURATION	0 ↔ 5	Tab. 13-6

PARAMETER VALUE	DESCRIPTION
0	CHILLER
1	AIR/WATER HEAT PUMP
2	HEAT PUMP WITHOUT DEFROST (WATER/WATER)
3	CHILLER WITH TOTAL RECOVERY
5	CHILLER WITH FREE COOLING

Table 13-6 UNIT CONFIGURATION

65	M	ALARM LIST ERASING:	1: CLEAR	0
69	CO	OPERATING HOURS COMPRESSOR N° 1	0 set operating hours to zero n>1: n is the number of hours	----- hrs
70	CO	OPERATING HOURS COMPRESSOR N° 2		----- hrs
71	CO	OPERATING HOURS COMPRESSOR N° 3		----- hrs
72	CO	OPERATING HOURS COMPRESSOR N° 4		----- hrs
73	M	2: ENABLES 2-COMPRESSOR KEYBOARD 4: ENABLES 4-COMPRESSOR KEYBOARD	2 ↔ 4	2 Num
77	M	POLARITY OF WATER FLOW SWITCH INPUT ON PRIMARY CIRCUIT	0=FLOW SWITCH ALARM WITH CLOSE CONTACT 1= FLOW SWITCH ALARM WITH OPEN CONTACT SWITCH	1 flag
78	M	POLARITY OF WATER FLOW SWITCH INPUT ON SECONDARY CIRCUIT	0= FLOW SWITCH ALARM WITH CLOSE CONTACT 1= FLOW SWITCH ALARM WITH OPEN CONTACT SWITCH	0 flag
79	M	PRIMARY CIRCUIT FLOW SWITCH ALARM DELAY TIME WITH UNITS IN OPERATION	0 ↔ 500	1 sec
80	M	SECONDARY CIRCUIT FLOW SWITCH ALARM DELAY TIME WITH UNITS IN OPERATION	0 ↔ 500	1 sec

81	M	Δt FOR FAN SPEED REGULATION IN FREE COOLING OPERATION	0 ↔ 500	2 °C
82	M	TYPE OF INTEGRAL REGULATION	0=MEAN INTEGRAL 1=ABSOLUTE INTEGRAL	1 flag
83	M	MINIMUM TIME BETWEEN TWO LOAD VARIATIONS DURING THE CONTROLLED STARTUP PROCEDURE	0 ↔ 600	0 sec
84	M	MAXIMUM LOAD VARIATION DURING THE CONTROLLED STARTUP PROCEDURE	0 ↔ 100	100%
85	M	PRIMARY CIRCUIT INTEGRAL TIME	0 ↔ 600	0 sec
86	M	MAX CORRECTION VALUE APPLIED TO THE PRIMARY CIRCUIT THROUGH THE INTEGRAL REGULATION	0 ↔ 10	0 °C
87	M	SECONDARY CIRCUIT INTEGRAL TIME	0 ↔ 600	0 sec
88	M	MAX CORRECTION VALUE APPLIED TO THE SECONDARY CIRCUIT THROUGH THE INTEGRAL REGULATION	0 ↔ 10	0 °C
89	M	REFERENCE PROBE FOR INTEGRAL REGULATION ON PRIMARY CIRCUIT	0=INLET PROBE 1=OUTLET PROBE	0 flag
90	M	REFERENCE PROBE FOR INTEGRAL REGULATION ON SECONDARY CIRCUIT	0= INLET PROBE 1= OUTLET PROBE	0 flag
91	M	MODE IN WHICH THE THERMOREGULATOR ACTIVATES RESOURCES	0=COMPLETE ACTIVATION OF A COOLING CIRCUIT BEFORE PASSING TO THE NEXT ONE 1=DISTRIBUTION OF STEPS BETWEEN COOLING CIRCUITS	0
92	M	MAINS FREQUENCY VISUALISATION	-----	Hz
93	M	MAINS VOLTAGE VISUALISATION	-----	V
94	C	LOW PRESSURE ALARM DELAY IN DEFROST MODE	0 ↔ 500	300 sec
95	M	SET VARIATION STARTING PERCENTAGE IN FREE-COOLING MODE	0 ↔ 100	80%
96	M	SET VARIATION END PERCENTAGE IN FREE-COOLING MODE	0 ↔ 100	20%
97	M	MAXIMUM SET VARIATION IN FREE COOLING MODE	0 ↔ 50	0 °C
98	M	MINIMUM DIFFERENCE BETWEEN INLET WATER TEMPERATURE AND AMBIENT AIR TEMPERATURE TO START FREE COOLING OPERATION	0 ↔ 50	1 °C
99	M	MAXIMUM DIFFERENCE BETWEEN AMBIENT AIR TEMPERATURE AND INLET WATER TEMPERATURE TO END FREE COOLING OPERATION	0 ↔ 50	1 °C

100	CO	TYPE OF COMPRESSOR STARTUP:	0=DIRECT 1=PART-WINDING	1 flag
101	M	TOTAL NUMBER OF COMPRESSORS	1 ↔ 4	1-8 num
102	CO	NUMBER OF CAPACITY STEPS PER COMPRESSOR	0 ↔ 3	0-3 num
103	C	NUMBER OF SOLENOID VALVES PER CIRCUIT	1	1 num
104	C	NUMBER OF VENTILATION CONTROL STEPS PER CIRCUIT	0 ↔ 4	0-4 num
105	C	NUMBER OF 4-WAY VALVES PER CIRCUIT (WRAN).	0 ↔ 1	0-1 num
106	M	-----	0 ↔ 1	0
107	M	NUMBER OF ANTIFREEZE REALYS	1 ↔ 2	1-2 num
108	M	NUMBER OF RELAYS FOR FREE COOLING	0 ↔ 1	0-1 num
109	M	PRESENCE OF PROBES IN HOT WATER CIRCUIT	0 ↔ 1	0-1 flag
110	M	NUMBER OF PROBES AT COLD WATER OUTLET	1 ↔ 9	1-3 num
111	M	NUMBER OF PROBES AT HOT WATER OUTLET	0 ↔ 9	0-3 num
112	M	TOTAL NUMBER OF DEFROST PROBES	0 ↔ 8	0-4 num
114	M	NUMBER OF TEMPERATURE PROBES FOR FREE COOLING	0 ↔ 2	0-2 num
115	C	NUMBER OF RECOVERY RELAYS PER CIRCUIT	0 ↔ 1	0-1 num
116	C	ENABLE PUMP-DOWN AT STARTUP (IT IS EFFECTIVE ONLY IF PUMP-DOWN AT SHUTDOWN IS ENABLED) IT MUST BE 0 FOR UNITS WITH SCREW COMPRESSORS	0=NOT ENABLED 1=ENABLED	0 flag
117	M	VOLTAGE ALARM ENABLING/DISABLING	0 = DISABLED 1 = ENABLED	1
118	M	FREQUENCY ALARM ENABLING/DISABLING	0 = DISABLED 1 = ENABLED	1

120	M	ST1 temperature probe offset	-10 ↔ 10	0.0 °C
121	M	ST2 temperature probe offset	-10 ↔ 10	0.0 °C
122	M	ST3 temperature probe offset	-10 ↔ 10	0.0 °C
123	M	ST4 temperature probe offset	-10 ↔ 10	0.0 °C
124	M	ST5 temperature probe offset	-10 ↔ 10	0.0 °C
125	M	ST6 temperature probe offset	-10 ↔ 10	0.0 °C

128	CI	VIEW OF C1 SUBCOOLING TEMPERATURE	-----	--- °C
129	CI	VIEW OF C2 SUBCOOLING TEMPERATURE	-----	--- °C

136	M	HYSTERESIS TO ENABLE PROPORTIONAL REGULATION AT PRIMARY CIRCUIT OUTLET	-10 ↔ 10	°C
137	M	HYSTERESIS TO ENABLE PROPORTIONAL REGULATION AT SECONDARY CIRCUIT OUTLET	-10 ↔ 10	°C
138	M	FAN ACTIVATION HYSTERESIS IN FREE-COOLING MODE	-10 ↔ 10	1 °C
139	M	OFFSET FOR FAN ACTIVATION IN FREE-COOLING MODE	-10 ↔ 10	2 °C
140	M	FAN SHUTDOWN DELAY IN FREE-COOLING MODE	0 ↔ 500	20 sec
141	M	FAN STARTUP DELAY IN FREE-COOLING MODE	0 ↔ 500	20 sec

142	M	ENABLING CONDENSING PRESSURE RELAY	0 ↔ 2	0 Num
143	M	RELAY 1 SET POINT	0 ↔ 30	10.0 Bar
144	M	RELAY 1 PROPORTIONAL BAND	0 ↔ 10	5.0 Bar
145	M	RELAY 2 SET POINT	0 ↔ 30	9.5 Bar
146	M	RELAY 2 PROPORTIONAL BAND	0 ↔ 10	0.5 Bar
152	M	SP1 HP pressure probe offset CIRCUIT N°1	-10 ↔ 10	0.0 Bar
153	M	SP2 HP pressure probe offset CIRCUIT N°2	-10 ↔ 10	0.0 Bar
183	M	CURRENT OPERATING HOUR	-----	num
190	M	0: MODEM DISABLED 1: Enables the unit to answer calls by modem 2: Enables the unit to answer and call by modem	0 ↔ 2	0 Num
191	M	Mask for machine alarms which activate the call	0 ↔ 0xFFFF	0 Mask
192	M	Mask for circuit alarms which activate the call	0 ↔ 3F	0 Mask
193	M	Mask for compressor alarms which activate the call	0 ↔ 0F	0 Mask
194	M	Type of serial port listening prior to the transmission of the initialisation command	0 ↔ 120	4 sec
195	M	Type of serial port listening prior to the transmission of the connection command	0 ↔ 120	60 sec
196	M	Maximum number of call attempts to the same number	0 ↔ 5	2 Num
197	M	Delay time between two successive attempts to call the same number	0 ↔ 600	10 sec
198	M	Maximum wait time for reply after the initialisation command	0 ↔ 120	2 sec
199	M	Maximum wait time for reply after the connection command	0 ↔ 120	45 sec
209	M	PRESENCE OF HIGH PRESSURE TRANSDUCERS	0 ↔ 1	1 Flag
210	M	first step HP set	0 ↔ 30	14 Bar
211	M	first step HP differential	0 ↔ 10.5	2.0 Bar
212	M	Second step HP set	0 ↔ 30	15.5 Bar
213	M	second step HP differential	0 ↔ 10.5	2 Bar
214	M	third step HP set	0 ↔ 30	17 Bar
215	M	third step HP differential	0 ↔ 10.5	2 Bar
216	M	fourth step HP set	0 ↔ 30	18 Bar
217	M	fourth step HP differential	0 ↔ 10.5	2 Bar
226	M	Activation of HP steps	0=continuous activation (step regulation) 1= activation with switch-over to fan feed from auto-transformer (continuous step regulation)	0
229	M	-----	0 ↔ 1	0 Flag
230	M	HOT WATER SET POINT HIGHER LIMIT	-20 ↔ 100	50 °C
231	M	HOT WATER SET POINT LOWER LIMIT	-20 ↔ 100	30 °C
232	M	COLD WATER SET POINT HIGHER LIMIT	-20 ↔ 100	12 °C
233	M	COLD WATER SET POINT LOWER LIMIT	-50 ↔ 100	5 °C
234	M	HOT WATER Δt HIGHER LIMIT	1 ↔ 50	5 °C
235	M	HOT WATER Δt LOWER LIMIT	1 ↔ 50	1 °C
236	M	COLD WATER Δt HIGHER LIMIT	1 ↔ 50	5 °C
237	M	COLD WATER Δt LOWER LIMIT	1 ↔ 50	1 °C

240	C	TIME REMAINING TO CIRCUIT 1 END OF DEFROST CYCLE	-----	min
241	C	TIME REMAINING TO CIRCUIT 2 END OF DEFROST CYCLE	-----	min
242	C	TIME REMAINING TO CIRCUIT 3 END OF DEFROST CYCLE	-----	min
243	C	TIME REMAINING TO CIRCUIT 4 END OF DEFROST CYCLE	-----	min

244	M	ENABLING OF THE SUBCOOLING CONTROL	0 ↔ 1	0 Flag
245	M	DELAY TIME TO START SUBCOOLING REGULATION	0 ↔ 120	60 sec
246	M	DELAY TIME TO ACTIVATION OF SUBCOOLING RELAY	0 ↔ 120	30 sec
247	M	SUBCOOLING SET POINT	0 ↔ 100	5 °C
248	M	SUBCOOLING PROPORTIONAL BAND	0 ↔ 10	1 °C
249	M	TYPE OF REFRIGERANT GAS USED	1 ↔ 3	Tab. 13-7

PARAMETER VALUE	DESCRIPTION
1	R 22
2	R 134a
3	R 407c
4	R 404a

Table 13-7 TYPE OF REFRIGERANT GAS

270	M	1: ENABLE DATA LOGGER (see note in chap.9.8)	0 ↔ 1	1 Flag
-----	---	--	-------	--------

280	M	MAXIMUM OPERATING TIME ALLOWED WITH CAPACITY STEP ACTIVE	0 ↔ 300	0 min
281	M	FORCING TIME IN "FULL" CAPACITY OPERATION	0 ↔ 300	0 sec
282	CO	RESIDUAL TIME ALLOWED WITH CAPACITY STEP ACTIVE; COMPRESSOR 1	0 ↔ 300	----- min
283	CO	RESIDUAL TIME IN "FULL" CAPACITY OPERATION OF COMPRESSOR 1	0 ↔ 300	----- sec
284	CO	RESIDUAL TIME ALLOWED WITH CAPACITY STEP ACTIVE; COMPRESSOR 2	0 ↔ 300	----- min
285	CO	RESIDUAL TIME IN "FULL" CAPACITY OPERATION OF COMPRESSOR 2	0 ↔ 300	----- sec
290	M	ENABLING OF REMOTE SUMMER/WINTER SWITCH-OVER IN THE HEAT PUMPS	0 ↔ 1	0 flag
291	M	CONTROL INPUT POLARITY	0 ↔ 1	1 flag
292	M	COMPRESSOR FORCING TIME IN OFF AFTER REMOTE SWITCH-OVER	10 ↔ 3600	10 sec
293	M	INLET TEMPERATURE SET BEYOND WHICH NO ALARM IS TRIGGERED IN THE CHILLER → HEAT PUMP SWITCH-OVER	0 ↔ 50	30 °C
294	M	INLET TEMPERATURE SETTING BELOW WHICH NO ALARM IS TRIGGERED IN THE CHILLER → HEAT PUMP SWITCH-OVER	0 ↔ 50	20 °C

14 Enclosures

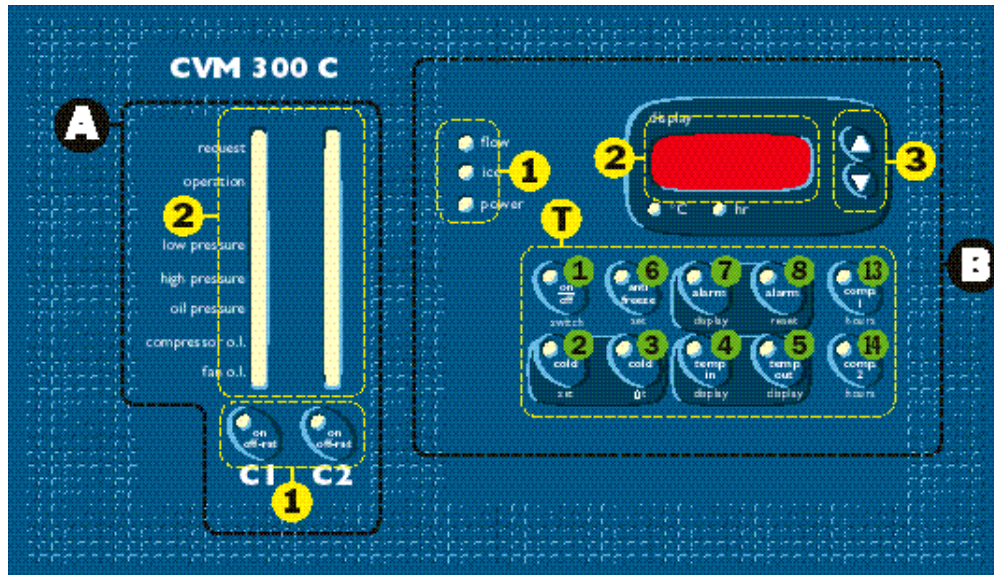

Figure 1

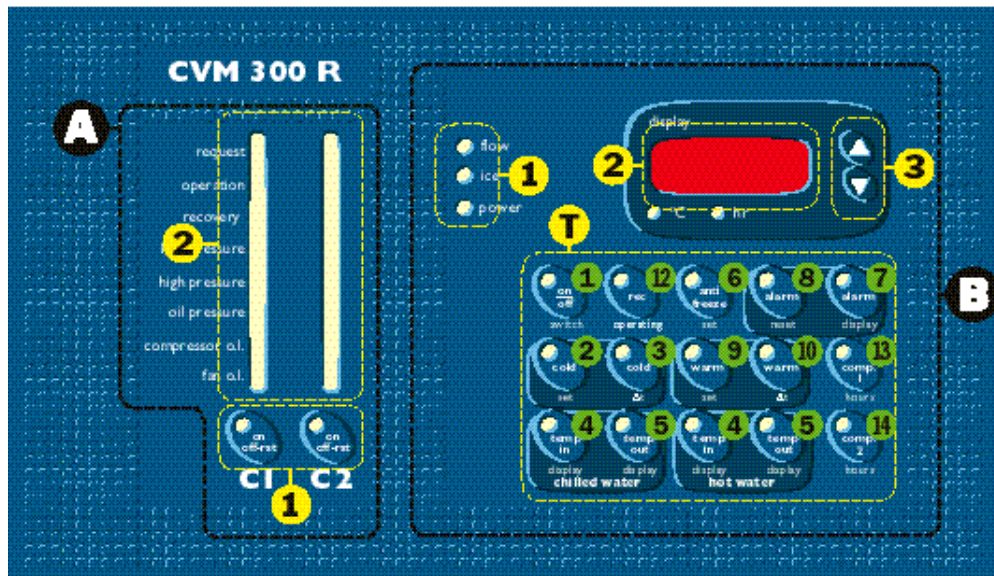

Figure 2

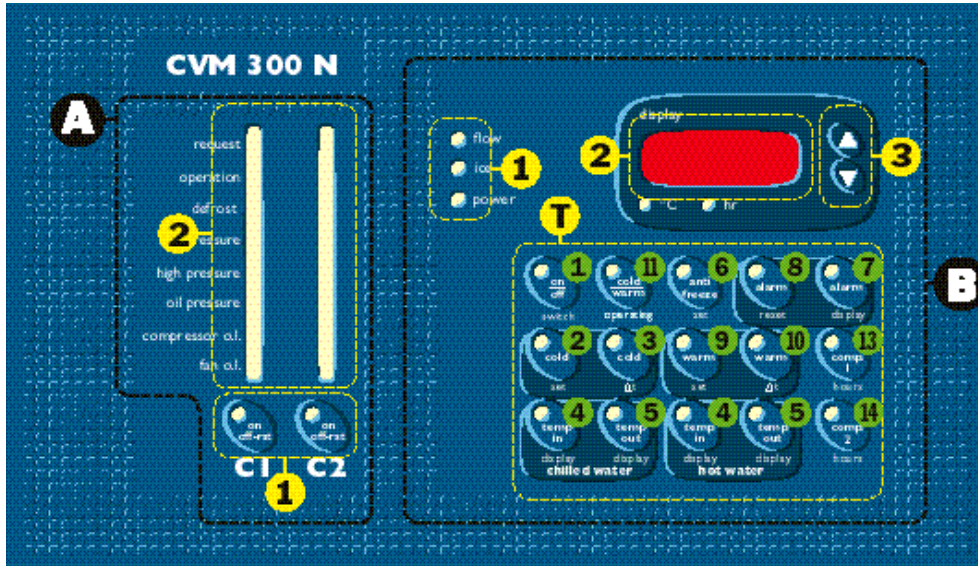

Figure 3

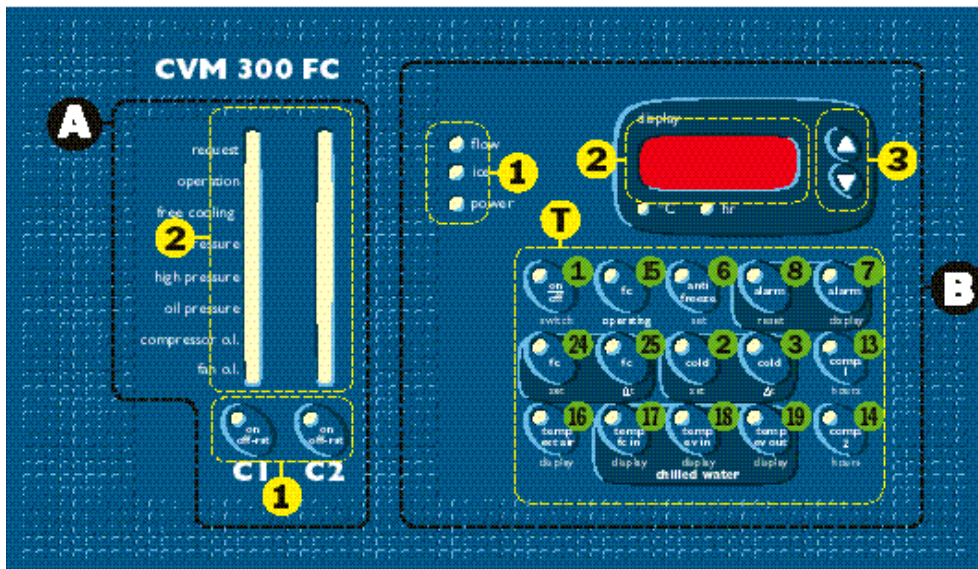

Figure 4